



iProject TI



iProject TI

IX (PTT) Fórum Regional - Fortaleza/CE

Quem somos!

A iProject é uma **empresa integradora de soluções em TI e Telecom** no mercado nacional com ampla expertise em todo Portfólio Cisco. Somos referência em atendimento nos mais diversos setores do mercado.

Nossos principais clientes estão na área de TI, Telecom e ISP (Internet Service Provider).





Soluções: Cisco Infraestrutura do ISP

Rua Monsenhor Bruno, 1153
Edifício Scopa Platinum Corporate, Aldeota - Fortaleza – CE - +55 85 2180-9988
Site: www.iprojectti.com.br | Email: comercial@iprojectti.com.br

Quanto custa não projetar sua rede para curto e longo prazo?

A Cisco pensa no modelo de segmentação dos ativos nas seguintes camadas:

- TRANSPORTE
- BORDA / CORE
- AGREGAÇÃO / DISTRIBUIÇÃO
- ACESSO
- CPE

Objetivo: Manter o fluxo de tráfego linear afim de não saturar enlaces e não manter fibras acesas sem uso.



Topologia de Referencia

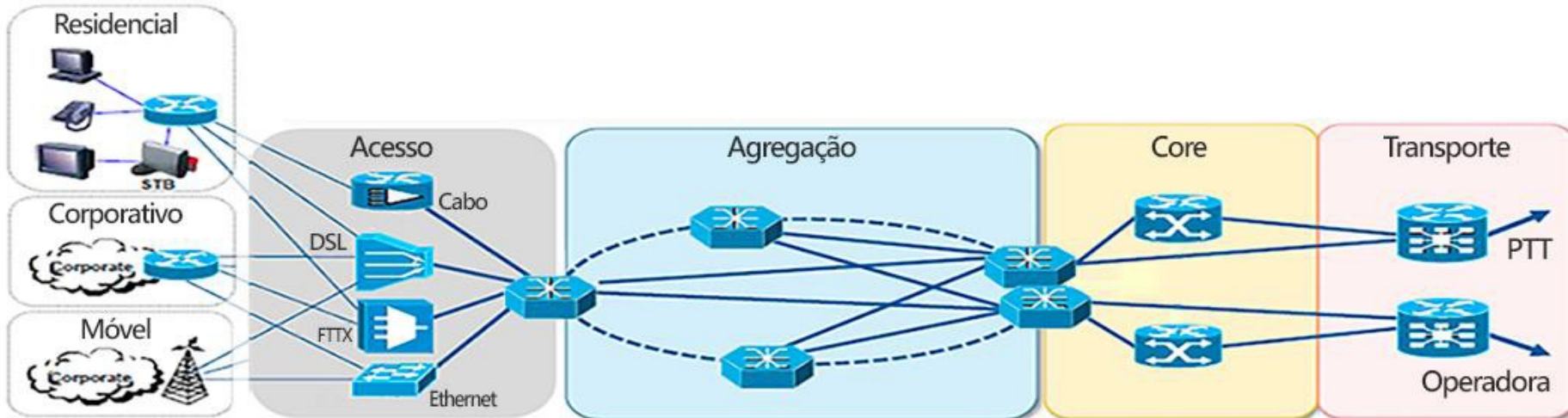

CPE
WiFi
SD WAN
Security
IPv6

FTTH, PON
GPON, STP,
REP, 802.1Q
Etc,

OSPF, MPLS,
VPLS, L3VPN

Segment Routing
BGP-eVPN

BGP, BNG
(PPPoE/IPoE/BRAS)
CGNAT,

NAT64

BGP
BGP Full
IPv4/IPv6

Service Provider Portfolio (P)

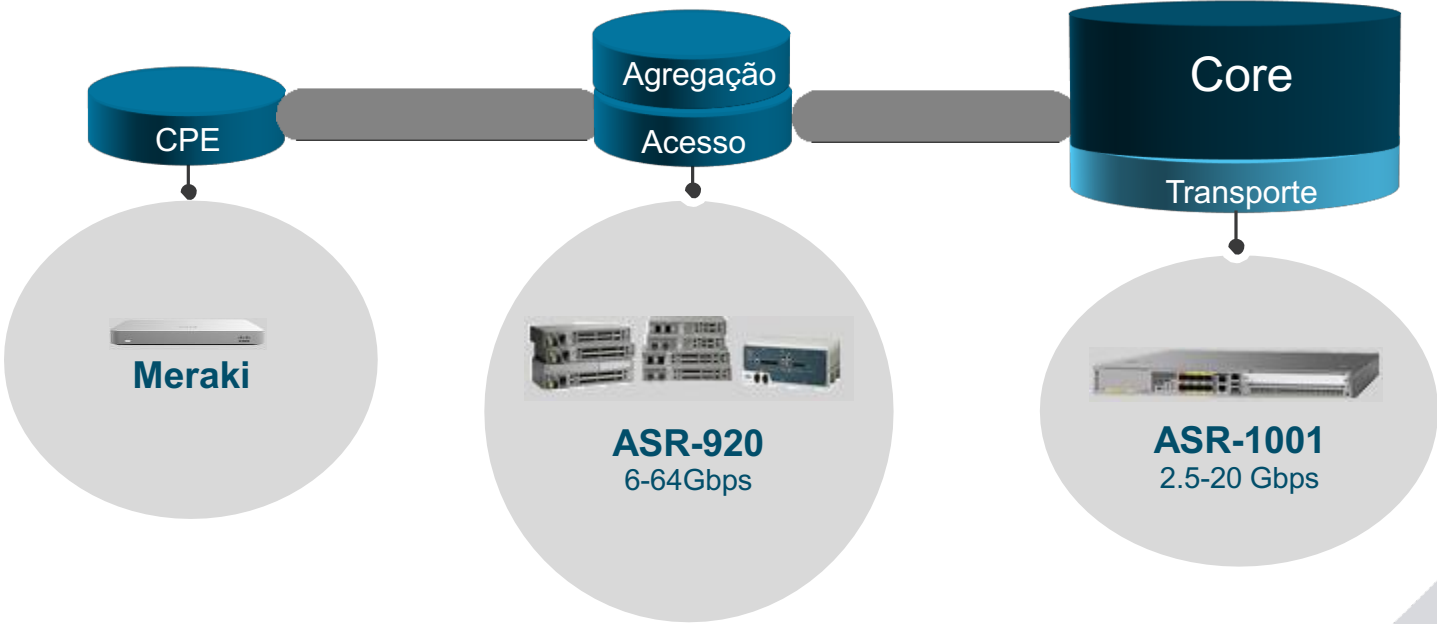

Service Provider Portfolio (P1)

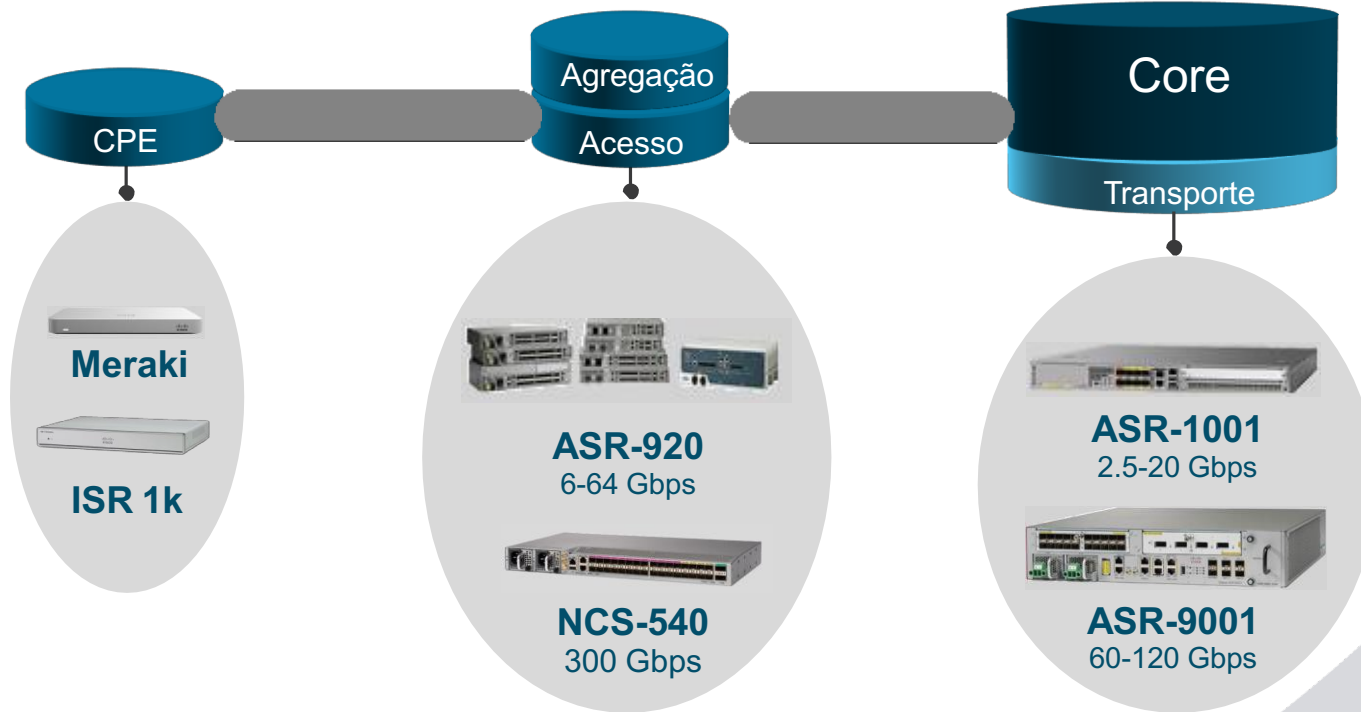

Service Provider Portfolio (M)

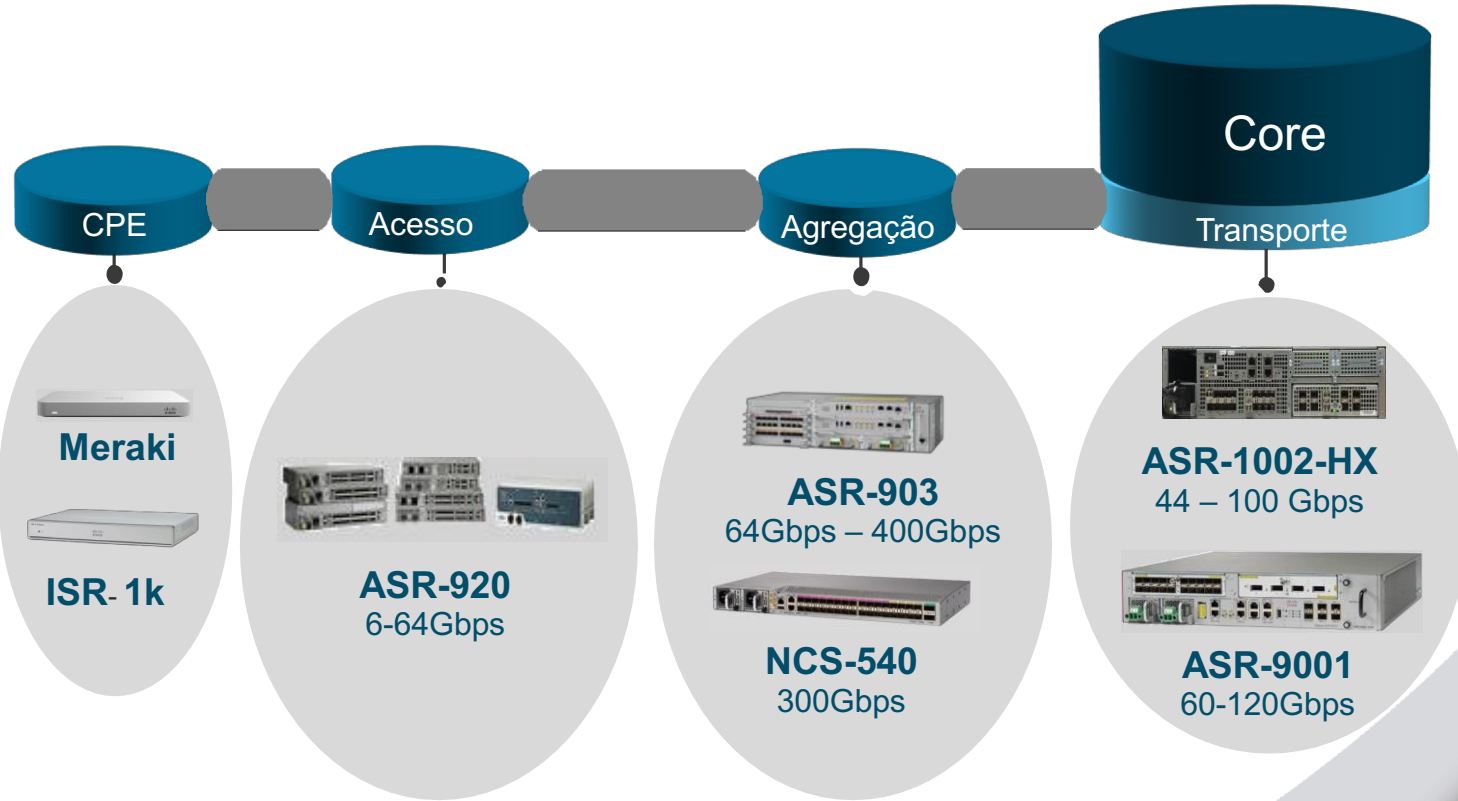

Service Provider Portfolio (M1)

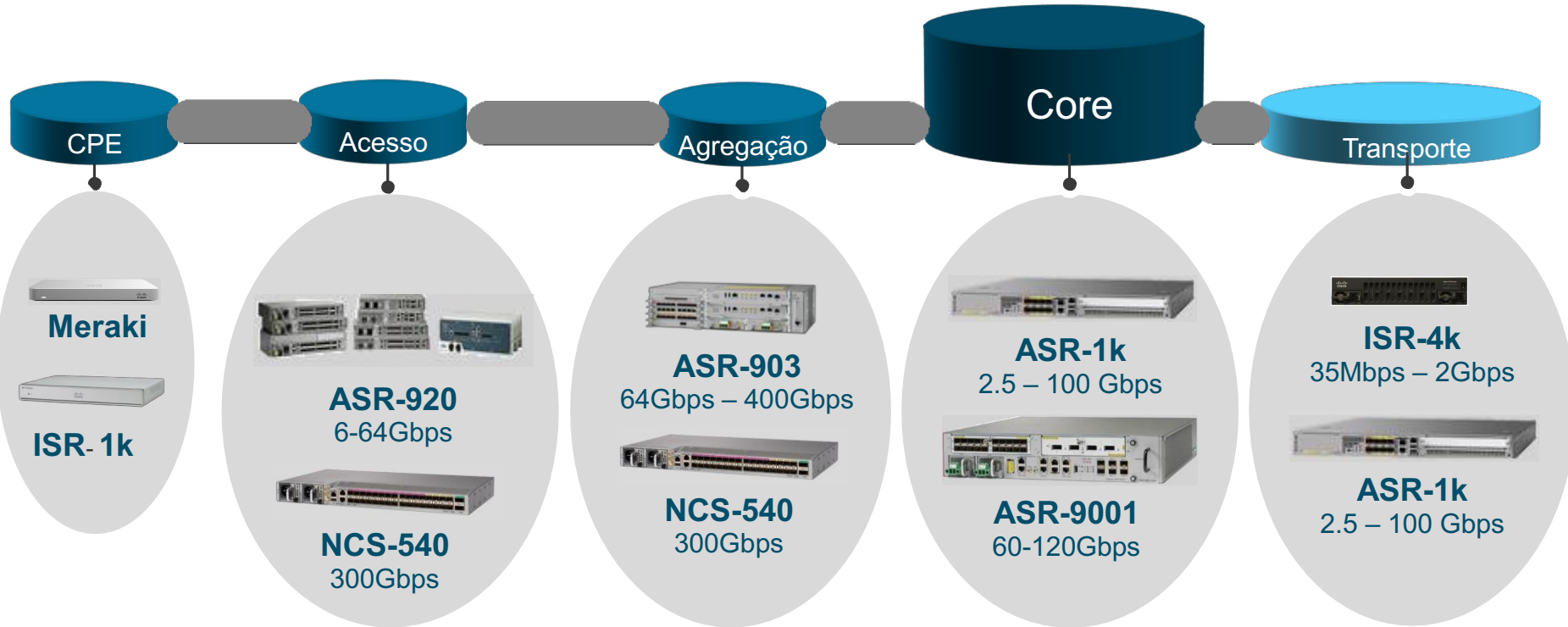

Service Provider Portfolio (G)

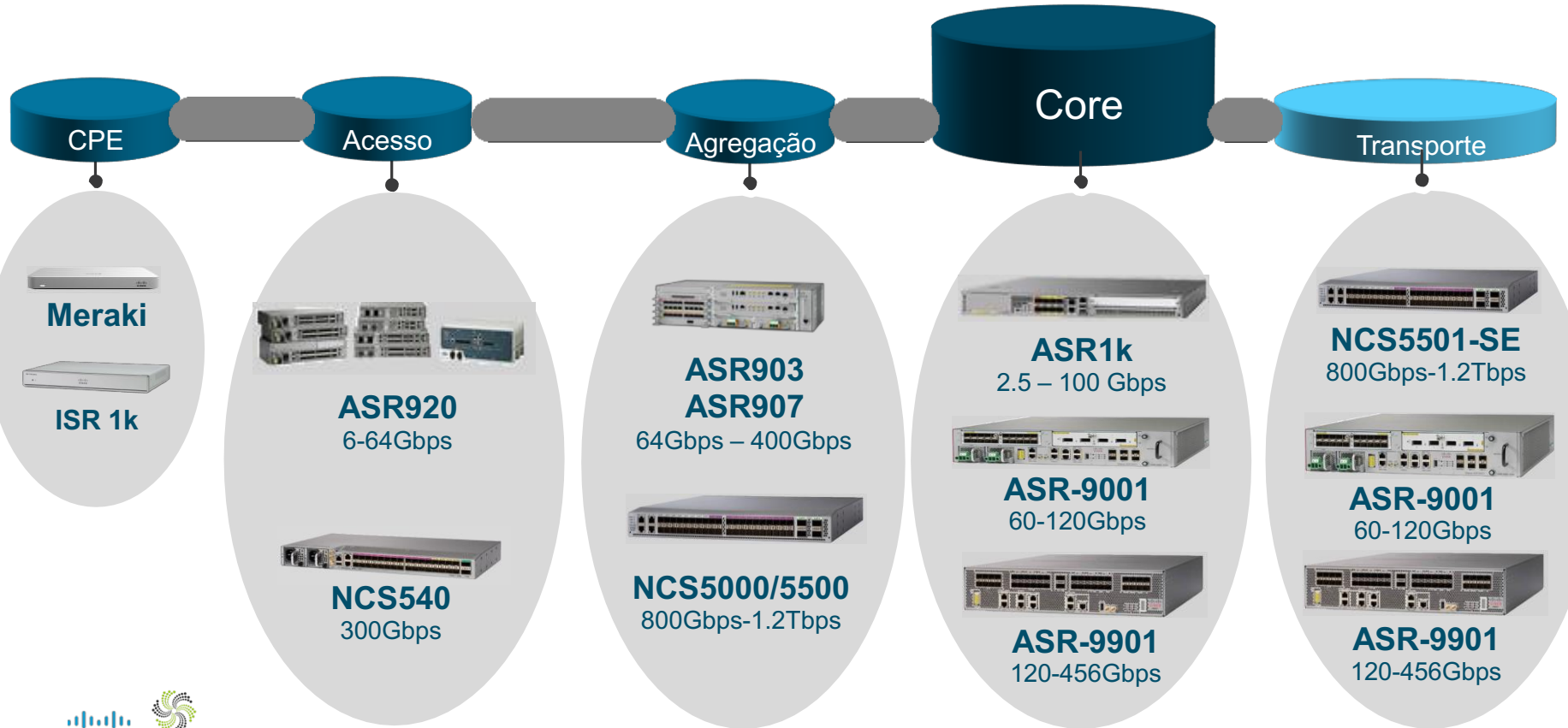



Topologia 3 em 1 respeitando recursos de cada funcionalidade com planejamento.

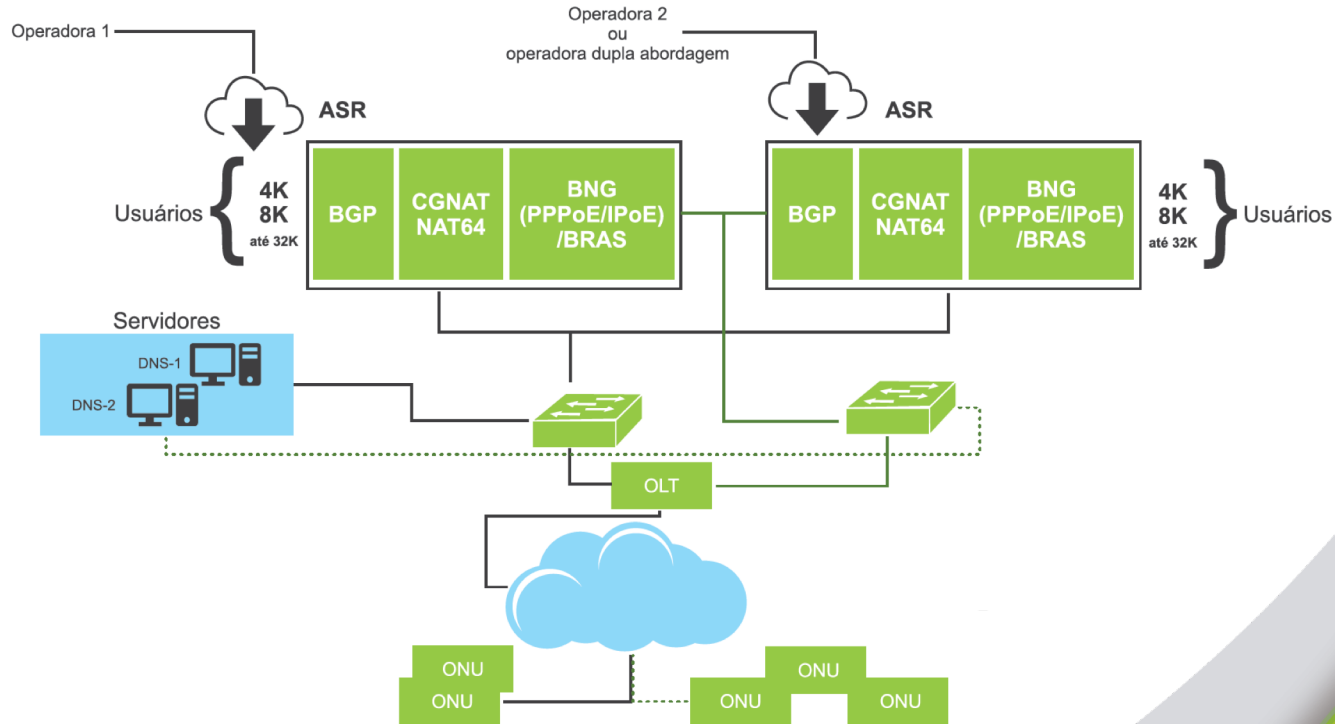

OPORTUNIDADE

3 EM 1

CISCO

Cisco ASR 1000-X



Cisco ASR 1000-HX





Principais Características	ASR-1001-X	ASR-1001-X	ASR-1001-HX
Memória RAM	8G	16G	16G
Portas SFP 1Gb	6	6	8
Portas SFP+ 10Gb	2	2	4
Portas SFP+ 1/10Gb	NÃO	NÃO	4
Portas Adicionais	SIM	SIM	NÃO
Throughput Max	20Gb	20Gb	88Gb
Tabela Roteamento V4	1.000.000	3.500.000	3.500.000
Tabela Roteamento V6	1.000.000	3.000.000	3.000.000
BGP – Router Reflector V4	5.250.000	11.500.000	11.500.000
BGP – Router Reflector V6	4.250.000	10.000.000	10.000.000
Total Tuneis (BNG) PPPoE	8.000	8.000	29.000
Sessões NAT (CGNat / NAT64)	2.000.000	2.000.000	4.000.000
L3VPN	SIM	SIM	SIM
L2VPN	SIM	SIM	SIM
MPLS	SIM	SIM	SIM
Certificação MEF	SIM	SIM	SIM
Segment Router MPLS / IPv6	SIM	SIM	SIM
SD Wan	SIM	SIM	SIM





Soluções Cisco para Service Provider (ISP)

Rua Monsenhor Bruno, 1153
Edifício Scopa Platinum Corporate, Aldeota - Fortaleza – CE - +55 85 2180-9988
Site: www.iprojectti.com.br | Email: comercial@iprojectti.com.br

PRODUTOS MERAKI



MR Wireless



MX Segurança



MS Switches



SM MDM



MV Câmeras



Cisco SD-WAN

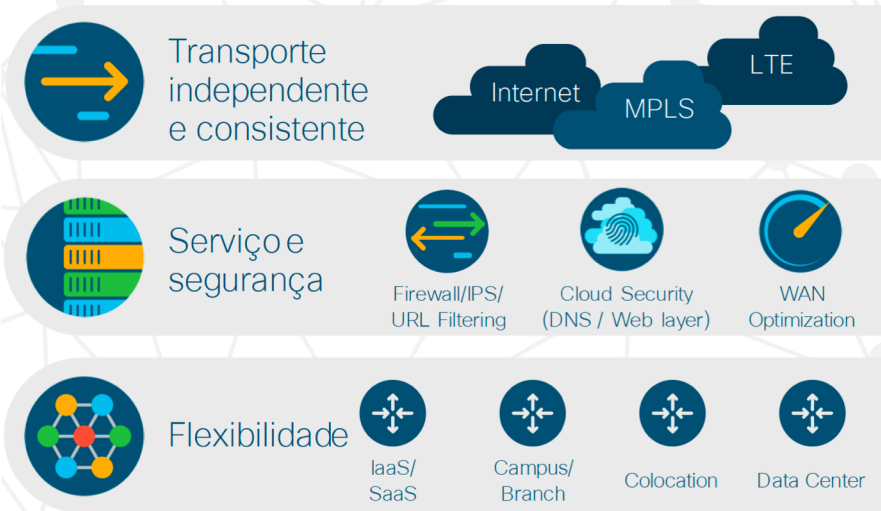

Meraki

Para equipes de TI pequenas, a Meraki simplifica o gerenciamento da filial e integra o gerenciamento de ameaças.



Amplie a rede baseada em intenção em filiais, WAN e nuvem.



Consultoria para concentração de tráfego local

Rua Monsenhor Bruno, 1153
Edifício Scopa Platinum Corporate, Aldeota - Fortaleza – CE - +55 85 2180-9988
Site: www.iprojectti.com.br | Email: comercial@iprojectti.com.br

Unir forças e crescer

Compartilhamento de Infraestrutura

- Rede física
- Matrizes de Roteamento (BGP/CORE)
- Autenticação e CGNAT (BNG/CGNAT)
- CDNs
- Data Center
- IXs Privados

Vantagens:

- Redução de custos
- Novos modelos de negócio
- Melhor aproveitamento da infraestrutura
- Aumento de SLA
- Segurança de investimento
- Suporte as necessidades da rede por mais tempo
- Facilidade de financiamento
- Segurança jurídica





Consultoria

- **Sociedade, Aquisições e Fusões**
- Organizar Operações Menores
- Definição de Avaliação
- Estabelecer metodologia
- Avaliação Financeira
- Administrativa
- Operacional
- Técnica
- Capacitação
- Novos modelos de negócio
- Fornecimento de equipamentos como Serviço
- Captação de Recursos

Rua Monsenhor Bruno, 1153
Edifício Scopa Platinum Corporate, Aldeota - Fortaleza – CE - +55 85 2180-9988
Site: www.iprojectti.com.br | Email: comercial@iprojectti.com.br





Oferta IX Fórum Fortaleza: NCS 540



Rua Monsenhor Bruno, 1153
Edifício Scopa Platinum Corporate, Aldeota - Fortaleza – CE - +55 85 2180-9988
Site: www.iprojectti.com.br | Email: comercial@iprojectti.com.br

NCS 540 Front & Back Details

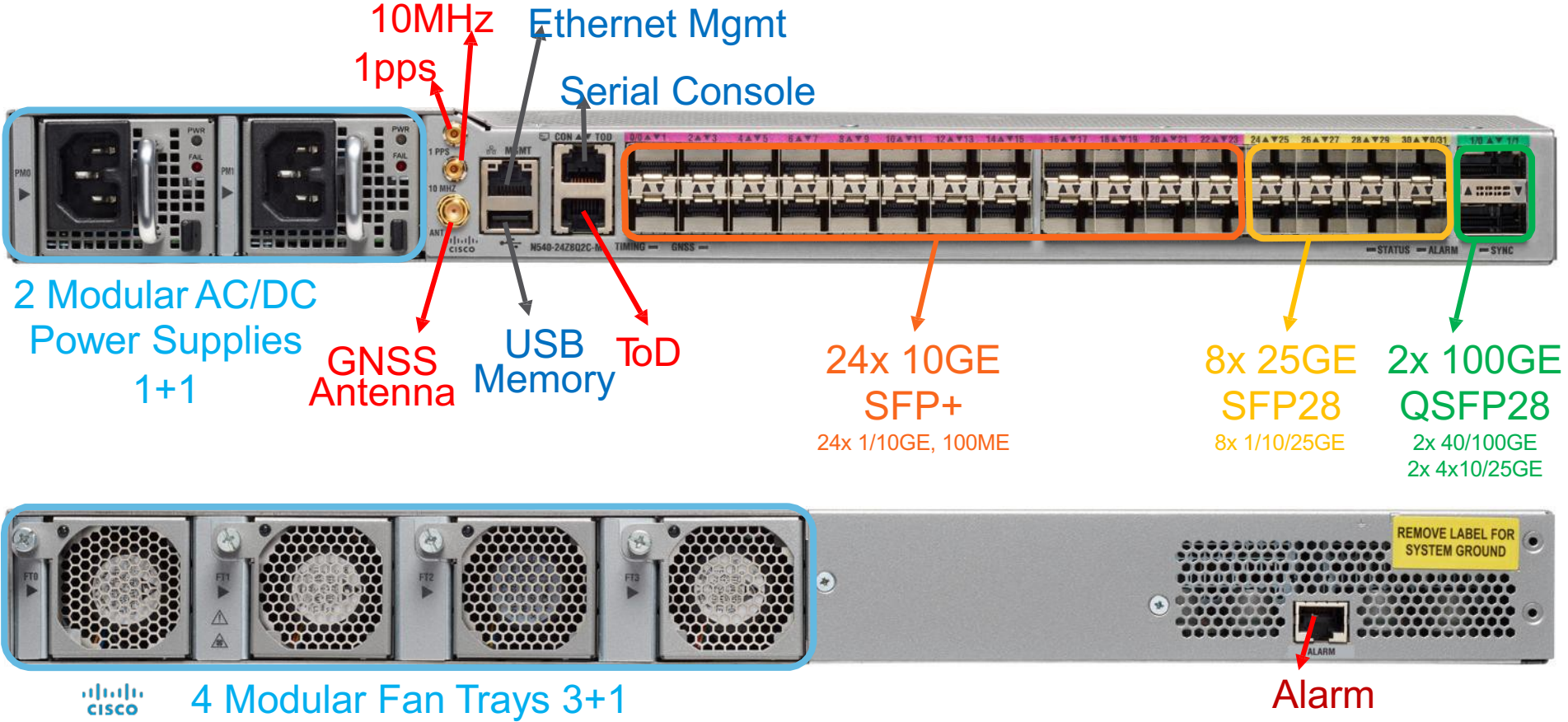

OBRIGADO!!!



Rua Monsenhor Bruno, 1153
Edifício Scopa Platinum Corporate, Aldeota - Fortaleza – CE - +55 85 2180-9988
Site: www.iprojectti.com.br | Email: comercial@iprojectti.com.br